

R:	20.	1.	7.	4. 2.	5.	30. 36.	31.	35. 12.	9.	10. 11. 34.	13. 14. 15. 16.	17.	19.
C:		1.	2.		3.	8.		4.	5.	24. 6.	7. 23.	9.	10.

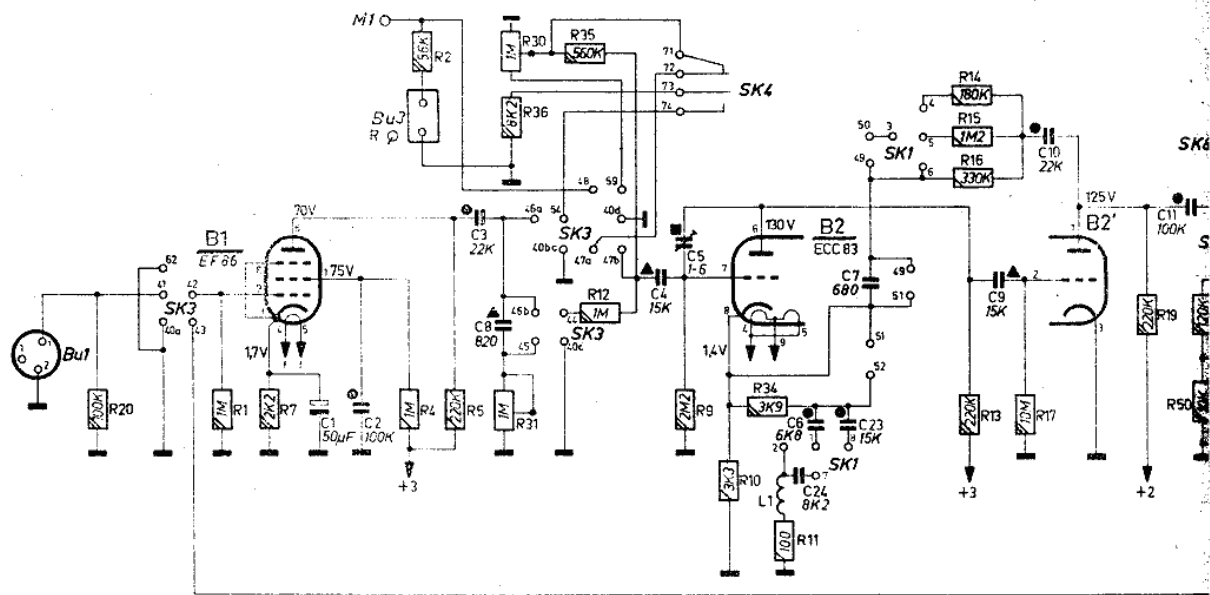

SK3

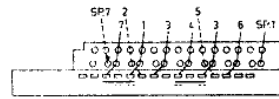

SK1

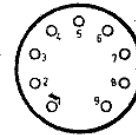

B1-B5

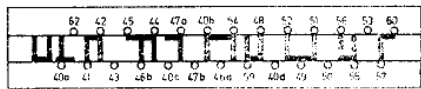

SK3
POSITION:
STOP

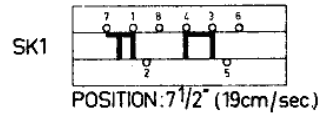

SK1
POSITION: 7 1/2" (19cm/sec)

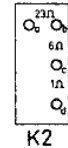

K2

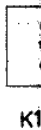

K1

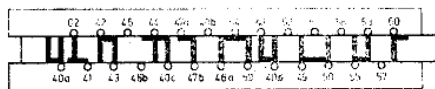

SK3
POSITION:
PLAY BACK

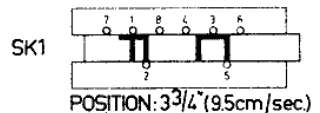

SK1
POSITION: 3 3/4" (9.5cm/sec)

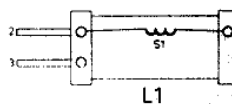

L1



SK2

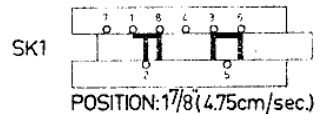

SK1
POSITION: 1 7/8" (4.75cm/sec)

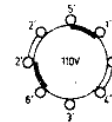

S1

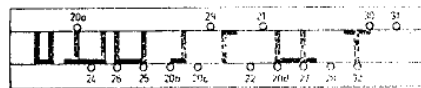

SK2
POSITION:
STOP

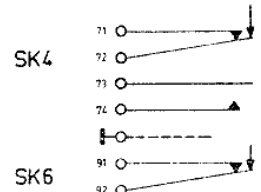

SK4

SK6

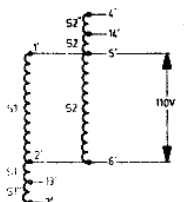

S2

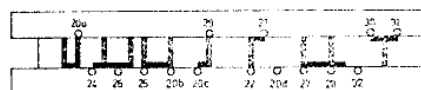

SK2
POSITION:
RECORDING

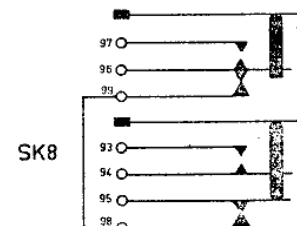

SK8